

HANGOVER MONOPOINT SURFACE CANOPY SUSPENSION

PROJECT
TYPE
SPECIFIER
QUANTITY
DATE

A300153-

base number	Color Temperature	Finishes (Diamond)	Finishes (Triangle)	Finishes (Circle)	Reflector Options	Shine Ring	Cable Options
-------------	-------------------	--------------------	---------------------	-------------------	-------------------	------------	---------------

- To build a product code in our configurator select the specify button on the base model # product page
- To build a manual product code on this datasheet choose from the options listed below in blue font and add the suffix to the base model #

GENERAL

Series: Hangover
 Subseries: Hangover Monopoint Surface Canopy
 Brand: Prolicht
 Division: Architectural
 Mounting Type: Suspension
 Mounting Location: Ceiling
 Subcategory: Pendant

PHYSICAL

Shape: Cylinder
 Diameter (mm): 40
 Diameter (in): 1 9/16
 Height (mm): 150
 Height (in): 5 7/8
 Max. Overall Height (mm): 2150
 Max. Overall Height (in): 84 5/8
 Light Distribution: Downlight
 Weight (kg): 0.75
 Weight (lbs): 1.65
 Diffuser: Shine Ring 0-6
 Fixture Finish: SSR / BKV / CWI / CRY / HAB / LAG / UFT / ITA / RUA / RUR / MIC / FTG / MYG / TWT / LOD / PUS / FRO / FUP / KIA / POP / BLS / SPG / MEY / GOH / GUM / CHC / COM / ABZ / JAG / OBR / MOS / ROR
 Fixture Material: Aluminum
 Cable Details: 2000mm / 6000mm Cable in White / Black / Orange / Red

ELECTRICAL

Lamp Type: LED (Zhaga Standard)
 Input Wattage (W): 10.9
 Total Output Wattage (W): 9
 Dimming: Non-Dimmable
 Driver Included: Yes
 Driver Location: Integrated
 Driver Type: Constant Current
 Driver Class: Class 2
 Input Voltage (V): 120
 Constant Current (MA): 500
 Upon Request: Remote: 0-10Vdc dimming / Phase dimming 120Vac

LED

Number of LEDs: 1
 Color Temperature (°K): 2700 / 3000 / 4000
 Max. Delivered Lumen (lm): 842
 CRI: >90 CRI
 Lamp Life (hrs): 50000

OPTICAL

Reflector: 40 / 50

RATINGS AND CERTIFICATIONS

Certified By: Certified for North American Standards
 IP rating: IP20

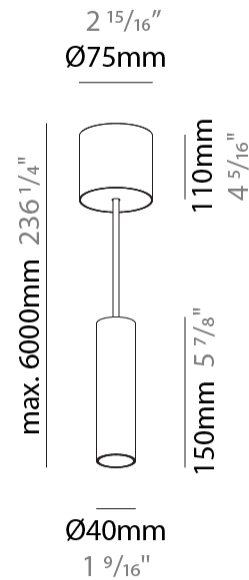

HANGOVER MONOPOINT SURFACE CANOPY SUSPENSION

A300153-

PROJECT
TYPE
SPECIFIER
QUANTITY
DATE



A

HANGOVER MONOPOINT SURFACE CANOPY SUSPENSION

PROJECT
TYPE
SPECIFIER
QUANTITY
DATE

A300154-

base number	Color Temperature	Finishes (Diamond)	Finishes (Triangle)	Finishes (Circle)	Reflector Options	Shine Ring	Cable Options
-------------	-------------------	--------------------	---------------------	-------------------	-------------------	------------	---------------

- To build a product code in our configurator select the specify button on the base model # product page
- To build a manual product code on this datasheet choose from the options listed below in blue font and add the suffix to the base model #

GENERAL

Series: Hangover
Subseries: Hangover Monopoint Surface Canopy
Brand: Prolicht
Division: Architectural
Mounting Type: Suspension
Mounting Location: Ceiling
Subcategory: Pendant

PHYSICAL

Shape: Cylinder
Diameter (mm): 40
Diameter (in): 1 9/16
Height (mm): 300
Height (in): 11 13/16
Max. Overall Height (mm): 2300
Max. Overall Height (in): 90 9/16
Light Distribution: Downlight
Diffuser: Shine Ring 0-6
Fixture Finish: SSR / BKV / CWI / CRY / HAB / LAG / UFT / ITA / RUA / RUR / MIC / FTG / MYG / TWT / LOD / PUS / FRO / FUP / KIA / POP / BLS / SPG / MEY / GOH / GUM / CHC / COM / ABZ / JAG / OBR / MOS / ROR
Fixture Material: Aluminum
Cable Details: 2000mm / 6000mmm Cable in White / Black / Orange / Red

ELECTRICAL

Lamp Type: LED (Zhaga Standard)
Input Wattage (W): 10.9
Total Output Wattage (W): 9
Dimming: Non-Dimmable
Driver Included: Yes
Driver Location: Integrated
Driver Type: Constant Current
Driver Class: Class 2
Input Voltage (V): 120
Constant Current (MA): 500
Upon Request: Remote: 0-10Vdc dimming / Phase dimming 120Vac

LED

Number of LEDs: 1
Color Temperature (°K): 2700 / 3000 / 4000
Max. Delivered Lumen (lm): 842
CRI: >90 CRI
Efficiency (%): 86
Lamp Life (hrs): 50000
Upon Request: ***3500K available in minimum quantities (larger quantities upon request)

OPTICAL

Reflector°: 40 / 50

RATINGS AND CERTIFICATIONS

Certified By: Certified for North American Standards
IP rating: IP20



PROJECT	_____
TYPE	_____
SPECIFIER	_____
QUANTITY	_____
DATE	_____

HANGOVER MONOPOINT SURFACE CANOPY SUSPENSION

A300154-

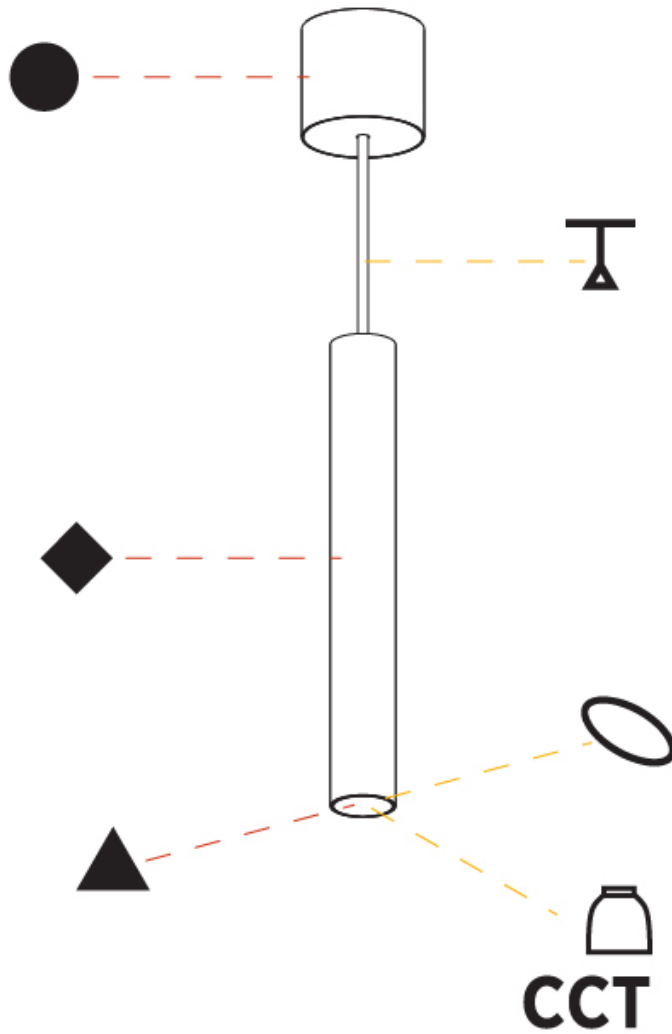

A

HANGOVER MONOPOINT SURFACE CANOPY SUSPENSION

PROJECT
TYPE
SPECIFIER
QUANTITY
DATE

A300155-

base number	Color Temperature	Finishes (Diamond)	Finishes (Triangle)	Finishes (Circle)	Reflector Options	Shine Ring	Cable Options
-------------	-------------------	--------------------	---------------------	-------------------	-------------------	------------	---------------

- To build a product code in our configurator select the specify button on the base model # product page
- To build a manual product code on this datasheet choose from the options listed below in blue font and add the suffix to the base model #

GENERAL

Series: Hangover
Subseries: Hangover Monopoint Surface Canopy
Brand: Prolicht
Division: Architectural
Mounting Type: Suspension
Mounting Location: Ceiling
Subcategory: Pendant

PHYSICAL

Shape: Cylinder
Diameter (mm): 40
Diameter (in): 1 9/16
Height (mm): 450
Height (in): 17 13/16
Max. Overall Height (mm): 2450
Max. Overall Height (in): 96 7/16
Light Distribution: Downlight
Diffuser: Shine Ring 0-6
Fixture Finish: SSR / BKV / CWI / CRY / HAB / LAG / UFT / ITA / RUA / RUR / MIC / FTG / MYG / TWT / LOD / PUS / FRO / FUP / KIA / POP / BLS / SPG / MEY / GOH / GUM / CHC / COM / ABZ / JAG / OBR / MOS / ROR
Fixture Material: Aluminum
Cable Details: 2000mm / 6000mm Cable in White / Black / Orange / Red

ELECTRICAL

Lamp Type: LED (Zhaga Standard)
Input Wattage (W): 10.9
Total Output Wattage (W): 9
Dimming: Non-Dimmable
Driver Included: Yes
Driver Location: Integrated
Driver Type: Constant Current
Driver Class: Class 2
Housing: ENCP3
Input Voltage (V): 120
Constant Current (mA): 500
Upon Request: Remote: 0-10Vdc dimming / Phase dimming 120Vac

LED

Number of LEDs: 1
Color Temperature (°K): 2700 / 3000 / 4000
Max. Delivered Lumen (lm): 842
CRI: >90 CRI
Efficiency (%): 86
Lamp Life (hrs): 50000
Upon Request: ***3500K available in minimum quantities (larger quantities upon request)

OPTICAL

Reflector: 40 / 50

RATINGS AND CERTIFICATIONS

Certified By: Certified for North American Standards
IP rating: IP20

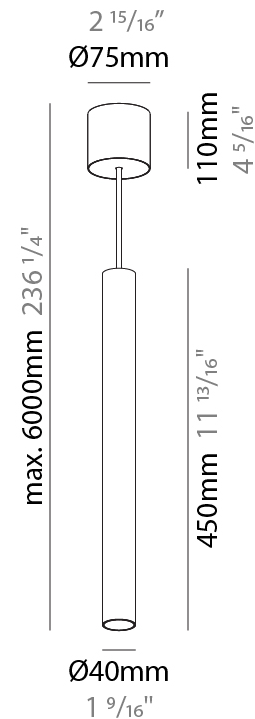
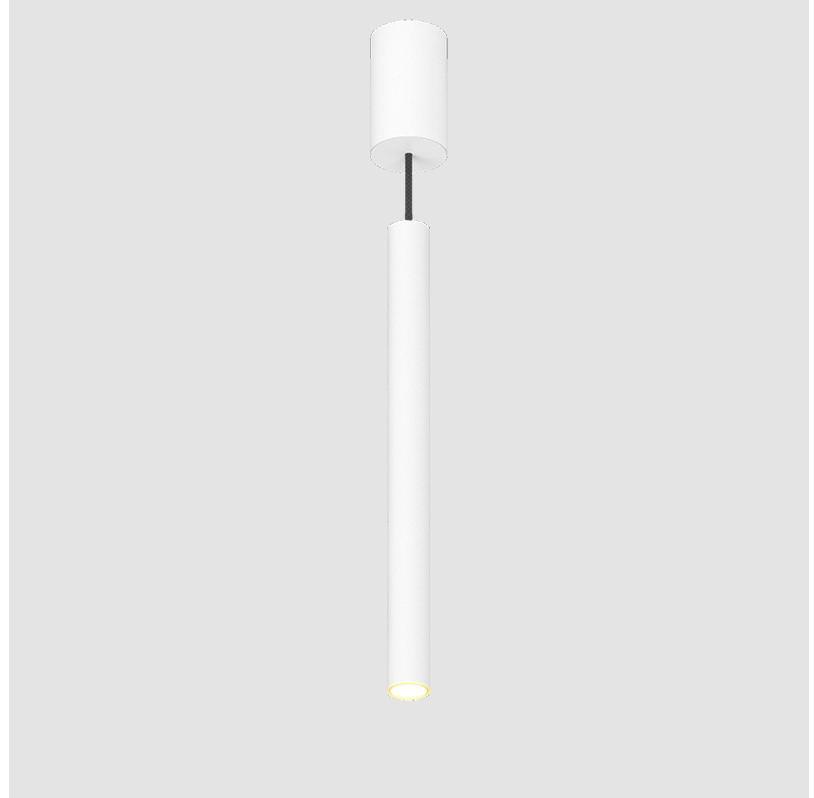

HANGOVER MONOPOINT SURFACE CANOPY SUSPENSION

A300155-

PROJECT
TYPE
SPECIFIER
QUANTITY
DATE

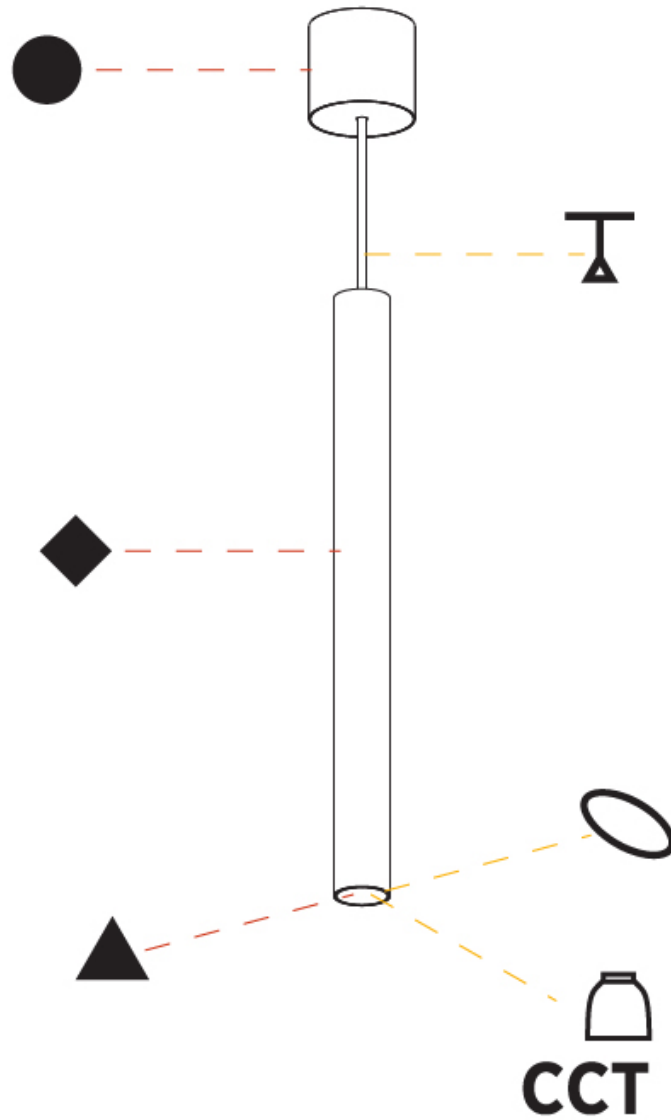

A

PROJECT
TYPE
SPECIFIER
QUANTITY
DATE

HANGOVER MONOPOINT SURFACE CANOPY SUSPENSION

A300164-

base number	Color Temperature	Finishes (Diamond)	Finishes (Triangle)	Finishes (Circle)	Reflector Options	Shine Ring	Cable Options
-------------	-------------------	--------------------	---------------------	-------------------	-------------------	------------	---------------

- To build a product code in our configurator select the specify button on the base model # product page
- To build a manual product code on this datasheet choose from the options listed below in blue font and add the suffix to the base model #

GENERAL

Series: Hangover
Subseries: Hangover Monopoint Surface Canopy
Brand: Prolicht
Division: Architectural
Mounting Type: Suspension
Mounting Location: Ceiling
Subcategory: Pendant

PHYSICAL

Shape: Cylinder
Diameter (mm): 75
Diameter (in): 2 ¹⁵ / ₁₆
Height (mm): 150
Height (in): 5 ⁷ / ₈
Max. Overall Height (mm): 2150
Max. Overall Height (in): 84 ⁵ / ₈
Light Distribution: Direct
Diffuser: Shine Ring 0-6
Fixture Finish: SSR / BKV / CWI / CRY / HAB / LAG / UFT / ITA / RUA / RUR / MIC / FTG / MYG / TWT / LOD / PUS / FRO / FUP / KIA / POP / BLS / SPG / MEY / GOH / GUM / CHC / COM / ABZ / JAG / OBR / MOS / ROR
Fixture Material: Aluminum
Cable Details: 2000mm / 6000mm Cable in White / Black / Orange / Red

ELECTRICAL

Lamp Type: LED (Zhaga Standard)
Input Wattage (W): 10.95
Total Output Wattage (W): 9.18
Dimming: Non-Dimmable
Driver Included: Yes
Driver Location: Integrated
Driver Type: Constant Current
Driver Class: Class 2
Input Voltage (V): 120
Constant Current (MA): 500
Upon Request: Remote: 0-10Vdc dimming / Phase dimming 120Vac / Non-dimming 120/277Vac

LED

Number of LEDs: 1
Color Temperature (°K): 2700 / 3000 / 4000
Max. Delivered Lumen (lm): 923
CRI: >90 CRI
Efficiency (%): 86
Lamp Life (hrs): 50000

OPTICAL

Reflector°: 18 / 36 / 52

RATINGS AND CERTIFICATIONS

Certified By: Certified for North American Standards
IP rating: IP20



HANGOVER MONOPOINT SURFACE CANOPY SUSPENSION

A300164-

PROJECT
TYPE
SPECIFIER
QUANTITY
DATE



A

HANGOVER MONOPOINT SURFACE CANOPY SUSPENSION

A300165-

base number	Color Temperature	Finishes (Diamond)	Finishes (Triangle)	Finishes (Circle)	Reflector Options	Shine Ring	Cable Options
-------------	-------------------	--------------------	---------------------	-------------------	-------------------	------------	---------------

- To build a product code in our configurator select the specify button on the base model # product page
- To build a manual product code on this datasheet choose from the options listed below in blue font and add the suffix to the base model #

GENERAL

Series: Hangover
 Subseries: Hangover Monopoint Surface Canopy
 Brand: Prolicht
 Division: Architectural
 Mounting Type: Suspension
 Mounting Location: Ceiling
 Subcategory: Pendant

PHYSICAL

Shape: Cylinder
 Diameter (mm): 75
 Diameter (in): 2 ¹⁵/₁₆
 Height (mm): 150
 Height (in): 5 ⁷/₈
 Max. Overall Height (mm): 2150
 Max. Overall Height (in): 84 ⁵/₈
 Light Distribution: Direct / Indirect
 Diffuser: Shine Ring 0-6
 Fixture Finish: SSR / BKV / CWI / CRY / HAB / LAG / UFT / ITA / RUA / RUR / MIC / FTG / MYG / TWT / LOD / PUS / FRO / FUP / KIA / POP / BLS / SPG / MEY / GOH / GUM / CHC / COM / ABZ / JAG / OBR / MOS / ROR
 Fixture Material: Aluminum
 Cable Details: 2000mm / 6000mm Cable in White / Black / Orange / Red

ELECTRICAL

Lamp Type: LED (Zhaga Standard)
 Input Wattage (W): 10.9
 Total Output Wattage (W): 9
 Dimming: Non-Dimmable
 Driver Included: Yes
 Driver Location: Integrated
 Driver Type: Constant Current
 Driver Class: Class 2
 Housing: ENCP3
 Input Voltage (V): 120
 Constant Current (MA): 500
 Upon Request: Remote: 0-10Vdc dimming / Phase dimming 120Vac

LED

Number of LEDs: 2
 Color Temperature (°K): 2700 / 3000 / 4000
 Max. Delivered Lumen (lm): 911
 CRI: >90 CRI
 Efficiency (%): 86
 Lamp Life (hrs): 50000

OPTICAL

Reflector: 18 / 36 / 52

RATINGS AND CERTIFICATIONS

Certified By: Certified for North American Standards
 IP rating: IP20

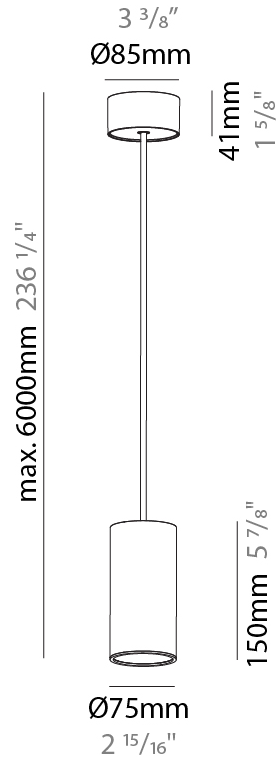

HANGOVER MONOPOINT SURFACE CANOPY SUSPENSION

A300165-

PROJECT
TYPE
SPECIFIER
QUANTITY
DATE



PROJECT
TYPE
SPECIFIER
QUANTITY
DATE

HANGOVER MONOPOINT SURFACE CANOPY SUSPENSION

A300166-

base number	Color Temperature	Finishes (Diamond)	Finishes (Triangle)	Finishes (Circle)	Reflector Options	Shine Ring	Cable Options
-------------	-------------------	--------------------	---------------------	-------------------	-------------------	------------	---------------

- To build a product code in our configurator select the specify button on the base model # product page
- To build a manual product code on this datasheet choose from the options listed below in blue font and add the suffix to the base model #

GENERAL

Series: Hangover
 Subseries: Hangover Monopoint Surface Canopy
 Brand: Prolicht
 Division: Architectural
 Mounting Type: Suspension
 Mounting Location: Ceiling
 Subcategory: Pendant

PHYSICAL

Shape: Cylinder
 Diameter (mm): 75
 Diameter (in): 2 15/16
 Height (mm): 300
 Height (in): 11 13/16
 Max. Overall Height (mm): 2300
 Max. Overall Height (in): 90 9/16
 Light Distribution: Downlight
 Diffuser: Shine Ring 0-6
 Fixture Finish: SSR / BKV / CWI / CRY / HAB / LAG / UFT / ITA / RUA / RUR / MIC / FTG / MYG / TWT / LOD / PUS / FRO / FUP / KIA / POP / BLS / SPG / MEY / GOH / GUM / CHC / COM / ABZ / JAG / OBR / MOS / ROR
 Fixture Material: Aluminum
 Cable Details: 2000mm / 6000mm Cable in White / Black / Orange / Red

ELECTRICAL

Lamp Type: LED (Zhaga Standard)
 Input Wattage (W): 10.9
 Total Output Wattage (W): 9
 Dimming: Non-Dimmable
 Driver Included: Yes
 Driver Location: Integrated
 Driver Type: Constant Current
 Driver Class: Class 2
 Housing: ENCP3
 Input Voltage (V): 120
 Constant Current (MA): 500
 Upon Request: Remote: 0-10Vdc dimming / Phase dimming 120Vac

LED

Number of LEDs: 1
 Color Temperature (°K): 2700 / 3000 / 4000
 Max. Delivered Lumen (lm): 923
 CRI: >90 CRI
 Efficiency (%): 86
 Lamp Life (hrs): 50000

OPTICAL

Reflector: 18 / 36 / 52

RATINGS AND CERTIFICATIONS

Certified By: Certified for North American Standards
 IP rating: IP20



HANGOVER MONOPOINT SURFACE CANOPY SUSPENSION

A300166-

PROJECT	_____
TYPE	_____
SPECIFIER	_____
QUANTITY	_____
DATE	_____



HANGOVER COLOR FINISH CHART

PROJECT _____
 TYPE _____
 SPECIFIER _____
 QUANTITY _____
 DATE _____

Fixture Finish



Digital: Not all screens are calibrated the same, and therefore, colors will appear differently between screens.
Physical: When texture is involved, there will be variations in color, character and tone within a product and between product families.

Gun Metal: No Gun Metal finish is alike. It combines a mixture of transparent and black color particles to ensure a highly individual effect and no luminaire being identical.
Champagne Cream, Copper Mine, Ancient Bronze & Jazz Gold: These finishes have slight fading from specific powder coating production. Each luminaire will slightly vary.

Available for International specifications by adding 'INT' at the end of the existing Model #. For assistance on 'custom' specifications, contact zteam@zaneen.com.
 In a constant effort to supply the best product, we reserve the right to change specifications or materials without notice. The most recent specification sheets are found at zaneen.com











LEGEND

	floor-mounted		pivotal		special LED (upon request) RGB, RGBW, tunable, gold+, meat+, art+, fashion+
	wall and ceiling: recessed and surface mounted		rotating		warm dim / natural dimming LED
	ceiling-mounted and wall-mounted		illuminate tilted		rechargeable battery powered
	wall-mounted		color of suspension cable		fixture with natural vivid LED (upon request)
	omni-directional light distribution		length of suspension cable		color rendering index
	direct light distribution		reflector degree selection		color temperature
	direct/indirect light distribution		super spot		lumen (luminous flux)
	indirect light distribution		lens		efficacy (lumens per watt)
	asymmetric light distribution		lens pack		Unified Glare Rating (UGR) range from 5-40
	aura light distribution		shine ring		marine grade (AISI 316 stainless steel)
	round wall or ceiling cut-out		integrated shine ring with diffuser		walk on
	square wall or ceiling cut-out		free individual colors 01-29		drive on
	the supplied jig specifies the cutout dimensions		individual colors: 00 (free of charge), 01-25 (extra charge)		Dark Sky Compliance
	minimum distance (meters) lamp - object		luminaire part to be colored (F1)		Americans with Disabilities Act (less than 4" off the wall located between 27"-84" from floor)
	recessed depth		luminaire part to be colored (F2)		lamp protected against explosion
	ceiling thickness in mm		luminaire part to be colored (F3)		blown glass using traditional methods by master glass blower
	ceiling thickness selection		luminaire part to be colored (F4)		acoustic material
	dimmable DP (phase), DV (0-10V), DD (dali), DS (step-dim)		luminaire part to be colored (F5)		protection class I, protection insulation
	included or excluded LED driver/transformer/control gear		color of 3-circuit adaptor		protection class II, protection insulation
	separately switchable		indirect diffuser		ETL Certified to UL and CSA Standards
	sensor		direct diffuser		UL Certified to UL and CSA Standards
	remote control		ball-proof (upon request)		CSA Certified to UL and CSA Standards
	available upon request		accessory		Certified for North American Standards

IP RATING

	protected against ingress of solid bodies greater than 12.5mm (finger)
	protected against ingress of solid bodies greater than 2.5mm protected against sprays of water up to 60 degrees from the vertical (rain)
	protected against ingress of solid bodies greater than 1mm (wire) no protection against the ingress of moisture
	protected against ingress of solid bodies greater than 1mm (wire) protected against sprays of water up to 60 degrees from the vertical (rain)
	protected against ingress of solid bodies greater than 1mm (wire) protected against water splashed from all directions
	protected against limited ingress of dust (wet rooms/covered outdoor areas) protected against water splashed from all directions
	protected against ingress of dust protected against jets of water
	protected against ingress of dust protected against powerful jets of water or heavy seas
	protected against ingress of dust protected against immersion of water between 15cm - 1m for 30 minutes
	protected against ingress of dust protected against immersion of water under pressure for long periods

IK RATING

	protected against 0.14 joules impact (equivalent to 0.25kg mass dropped from 56mm above the surface)
	protected against 0.2 joules impact (equivalent to 0.25kg mass dropped from 80mm above the surface)
	protected against 0.35 joules impact (equivalent to 0.25kg mass dropped from 140mm above the surface)
	protected against 0.5 joules impact (equivalent to 0.25kg mass dropped from 200mm above the surface)
	protected against 0.7 joules impact (equivalent to 0.25kg mass dropped from 280mm above the surface)
	protected against 1 joules impact (equivalent to 0.25kg mass dropped from 400mm above the surface)
	protected against 2 joules impact (equivalent to 0.5kg mass dropped from 400mm above the surface)
	protected against 5 joules impact (equivalent to 1.7kg mass dropped from 300mm above the surface)
	protected against 10 joules impact (equivalent to 5.0kg mass dropped from 200mm above the surface)
	protected against 20 joules impact (equivalent to 5.0kg mass dropped from 400mm above the surface)